

Orderformulär

F5 Corpus VS



F5 Corpus VS

Framhjuldriven elrullstol med individuell fjädring på alla 4 hjul.
Standardutrustad med luftfyllda däck.
Corpus VS sissystem med ergonomiska sits- och ryggstödsdynor.
Utrustad med elreglerade ryggstöd, benstöd, sitslyft och tilt.

Kontaktperson/Offertadress

Kund (Namn/Nummer)	/
Kontaktperson	
Adress	
Postnummer / Stad	/
Telefon/Fax	/

Användare

Namn	/
Adress	
Postnummer / Stad	/
Telefon	
E-postanvändare	

Diagnoser	
-----------	--

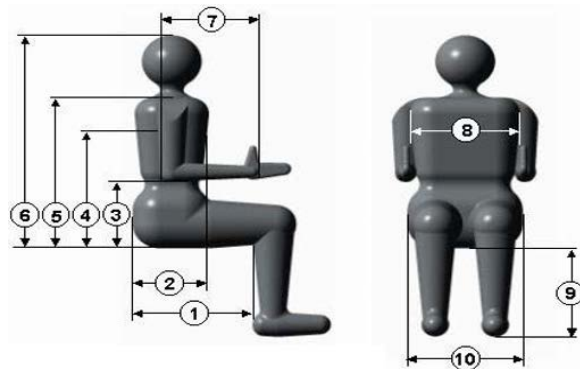

Anatomiska Dimensioner

Vikt:	kg	3:	cm	7:	cm
Längd:	cm	4:	cm	8:	cm
1:	cm	5:	cm	9:	cm
2:	cm	6:	cm	10:	cm

Referens användare

Namn/ref	
----------	--

- Krävs val
 / Valfritt val
 / Default önskat alternativ

Chassi

HASTIGHET 12 KM/H	107306-99-0	<input checked="" type="radio"/>			
HASTIGHET 10KM/H	107305-99-0	<input type="radio"/>			
Färg		<input checked="" type="radio"/>			
KÅPSATS SUNBURST ORANGE	107036-99-0	<input type="radio"/>			
KÅPSATS GALACTIC GREEN	107105-99-0	<input type="radio"/>			
KÅPSATS MIDNIGHT BLACK	107106-99-0	<input type="radio"/>			
KÅPSATS OCEAN BLUE	107107-99-0	<input type="radio"/>			
KÅPSATS PHANTOM GREY	107108-99-0	<input type="radio"/>			
KÅPSATS POWER PINK	107109-99-0	<input type="radio"/>			
KÅPSATS RADIANT RED	107110-99-0	<input type="radio"/>			
KÅPSATS TITAN BLUE	107111-99-0	<input type="radio"/>			

Drivhjul						
HJUL F5 3,00-8 LUFT SVART	107005-99-0	<input checked="" type="radio"/>				 107289-99-0 107005-99-0 106999-99-0
HJUL F5 3,00-8 SOLID SVAR	106999-99-0	<input type="radio"/>				
HJUL 3.00x8 MODD/SNÖ LUFTF5 SVART (par)	107289-99-0	<input type="radio"/>				
Länkhjul						
HJULSATS F5 210X65 LUFTSVART	107001-99-0	<input checked="" type="radio"/>				
HJULSATS F5 210X65 SOLIDSVART	107003-99-0	<input type="radio"/>				
Batterier						
BATTERIER 73AH	101989-99-0	<input checked="" type="radio"/>				
UTAN BATTERIER	100661-99-0	<input type="radio"/>				
Batteriladdare						
LADDARE PERMOBIL 24V/8AEU	104877-99-0	<input checked="" type="radio"/>				
UTAN LADDARE	100662-99-0	<input type="radio"/>				
Belysningssats						
REFLEXSATS	105717-99-0	<input checked="" type="radio"/>				
BELYSNINGSSATS FRAM/BAKF3/F5	106981-99-0	<input type="radio"/>				
BELYSNINGSSATS FRAM INKLREFLEX BAK F3/F5	107458-99-0	<input type="radio"/>				
BAKLJUS PÅ CHASSI OCHBAGAGEBOX	108099-99-0	<input type="checkbox"/>				
Stödhjul						
STÖDHJUL CORPUS VS	107027-99-0	<input checked="" type="checkbox"/>				
Chassi Tillbehör						
BAGAGEKORG F5 MED REFLEX	107459-99-0	<input type="radio"/>				 107459-99-0 107204-99-0 107006-99-0 107083-99-0 101888-99-0 107204-99-0 101897-99-0
BAGAGEKORG F5 MED LYSE	107204-99-0	<input type="radio"/>				
LÅSRATT CHASSI	107006-99-0	<input type="checkbox"/>				
DRIFTTIDSMÄTARE	107081-99-0	<input type="checkbox"/>				
FJÄRRSTOPP INKL. FÅSTE	107083-99-0	<input type="checkbox"/>				
REGNSKYDD STOLAR	101888-99-0	<input type="radio"/>				
REGNSKYDDPLASTVÄVSPRENNING	101897-99-0	<input type="radio"/>				
Sitsmontage						
SITSLYFT AP VS F5	107087-99-0	<input checked="" type="checkbox"/>				 107087-99-0 107095-99-0
SITSVINKLING	107095-99-0	<input checked="" type="radio"/>				
SITSVINKLING FAST	107096-99-0	<input type="radio"/>				
Sits						

Sitsstorlek											
		Djup									
	Storlek (mm)	370	395	420	445	470	495	520	545	570	
Bredd	420	<input type="radio"/>	<input type="radio"/>	<input type="radio"/>	<input type="radio"/>	<input type="radio"/>	<input type="radio"/>	<input type="radio"/>	<input type="radio"/>	<input type="radio"/>	
	470	<input type="radio"/>	<input type="radio"/>	<input checked="" type="radio"/>	<input type="radio"/>	<input type="radio"/>	<input type="radio"/>	<input type="radio"/>	<input type="radio"/>	<input type="radio"/>	
	520	<input type="radio"/>	<input type="radio"/>	<input type="radio"/>	<input type="radio"/>	<input type="radio"/>	<input type="radio"/>	<input type="radio"/>	<input type="radio"/>	<input type="radio"/>	
	570	<input type="radio"/>	<input type="radio"/>	<input type="radio"/>	<input type="radio"/>	<input type="radio"/>	<input type="radio"/>	<input type="radio"/>	<input type="radio"/>	<input type="radio"/>	
Sitsdyna											
SITSDYNA SKAI				10XXXX-99-0		<input checked="" type="radio"/>					
SITSDYNA MESH				10XXXX-99-0		<input type="radio"/>					
UTAN SITSDYNA C 3G				105118-99-0		<input type="radio"/>					
LÄRSTÖD ERGO (Vå/Hö)				105219-99-0		<input checked="" type="checkbox"/>					
Reglering ryggstöd											
STÄLLDON RYGG 180° CORPUSVS				107187-99-0		<input checked="" type="checkbox"/>					
RYGG FAST C 3G				105066-99-0		<input checked="" type="radio"/>					
RYGGSTÖD GLIDRYGG CORPUSVS				107030-99-0		<input type="radio"/>					
Ryggstöd											
KORT				107262-99-0		<input type="radio"/>					
STANDARD				107264-99-0		<input checked="" type="radio"/>					
UTAN RYGGSTÖD CORPUS				107272-99-0		<input type="radio"/>					
Ryggstödstorlek											
		Kort	Standardhöjder								
	Storlek (mm)	470	545	570	595	620	645	670			
Bredd	360	<input type="radio"/>	<input type="radio"/>	<input type="radio"/>	<input type="radio"/>	<input type="radio"/>	<input type="radio"/>	<input type="radio"/>			
	410	<input type="radio"/>	<input type="radio"/>	<input checked="" type="radio"/>	<input type="radio"/>	<input type="radio"/>	<input type="radio"/>	<input type="radio"/>			
	460	<input type="radio"/>	<input type="radio"/>	<input type="radio"/>	<input type="radio"/>	<input type="radio"/>	<input type="radio"/>	<input type="radio"/>			
	510	<input type="radio"/>	<input type="radio"/>	<input type="radio"/>	<input type="radio"/>	<input type="radio"/>	<input type="radio"/>	<input type="radio"/>			
Ryggdyna											
RYGGDYNA SKAI				10XXXX-99-0		<input checked="" type="radio"/>					
RYGGDYNA MESH				10XXXX-99-0		<input type="radio"/>					
UTAN RYGGSTÖDSDYNA C 3G				105117-99-0		<input type="radio"/>					
BÄLSTÖD C 3G LITET ERGO				105569-99-0		<input checked="" type="radio"/>					
BÄLSTÖD C 3G STORT ERGO				105570-99-0		<input type="radio"/>					
Bröststöd											
BRÖSTSTÖD FAST UTAN KUDDE				107174-99-0		<input type="radio"/>					
BRÖSTSTÖD JUSTERBART UTANKUDDE				107203-99-0		<input checked="" type="radio"/>					
BRÖSTSTÖD CORPUS				101303-99-0		<input type="radio"/>					
BRÖSTSTÖDSKUDDE 260 VSF5				107177-99-0		<input type="radio"/>					
BRÖSTSTÖDSKUDDE 310 VSF5				107176-99-0		<input checked="" type="radio"/>					
BRÖSTSTÖDSKUDDE 360				107175-99-0		<input type="radio"/>					

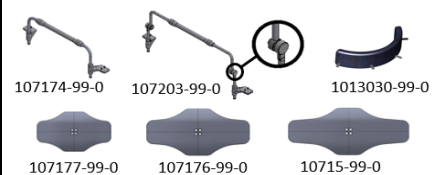
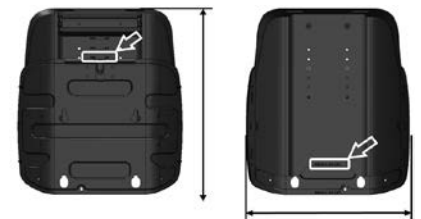

Armstödsfäste											
ARMSTÖDSAVSTÅND 380-480	107251-99-0	<input checked="" type="radio"/>									
ARMSTÖDSAVSTÅND 480-580	107252-99-0	<input type="radio"/>									
MONT POS MELLAN ARMSTÖD380mm C 3G	105083-99-0	<input type="radio"/>									
MONT POS MELLAN ARMSTÖD430mm C 3G	105084-99-0	<input checked="" type="radio"/>									
MONT POS MELLAN ARMSTÖD480mm C 3G	105085-99-0	<input type="radio"/>									
MONT POS MELLAN ARMSTÖD530mm C 3G	105086-99-0	<input type="radio"/>									
MONT POS MELLAN ARMSTÖD580mm C 3G	105082-99-0	<input type="radio"/>									
ARMSTÖDSHÖJD POS 2 255 MM	106632-99-0	<input type="radio"/>									
ARMSTÖDSHÖJD POS 3 280 MM	106633-99-0	<input checked="" type="radio"/>									
ARMSTÖDSHÖJD POS 4 305 MM	106634-99-0	<input type="radio"/>									
ARMSTÖDSHÖJD POS 5 330 MM	106635-99-0	<input type="radio"/>									
ARMSTÖDSFÄSTE FAST (PAR)	105070-99-0	<input checked="" type="radio"/>									
Armstöd											
		Vänster		Höger							
		260	335	410	460	260	335	410	460		
UTAN ARMSTÖD		<input type="radio"/>	<input type="radio"/>	<input type="radio"/>	<input type="radio"/>	<input type="radio"/>	<input type="radio"/>	<input type="radio"/>	<input type="radio"/>		
ARMSTÖD TREVIRA		<input type="radio"/>	<input type="radio"/>	<input type="radio"/>	<input type="radio"/>	<input type="radio"/>	<input type="radio"/>	<input type="radio"/>	<input type="radio"/>		
ARMSTÖD SKAI		<input type="radio"/>	<input checked="" type="radio"/>	<input type="radio"/>	<input type="radio"/>	<input type="radio"/>	<input checked="" type="radio"/>	<input type="radio"/>	<input type="radio"/>		
ARMSTÖD GEL		<input type="radio"/>	<input type="radio"/>	<input type="radio"/>	<input type="radio"/>	<input type="radio"/>	<input type="radio"/>	<input type="radio"/>	<input type="radio"/>		
Reglering benstöd											
STÄLLDON BEN CORPUS VS	107178-99-0			<input checked="" type="checkbox"/>							
Benstöd											
BENSTÖD CORPUS VS	106965-99-0			<input checked="" type="checkbox"/>							
Fotplattor											
FOTPLATTA 160 BEN 255-475	106967-99-0			<input type="radio"/>							
FOTPLATTA 200 BEN 255-475	106971-99-0			<input checked="" type="radio"/>							
FOTPLATTA HEL BEN 255-475	106969-99-0			<input type="radio"/>							
FOTPLATTA 160 BEN 135-255	106966-99-0			<input type="radio"/>							
FOTPLATTA 200 BEN 135-255	106970-99-0			<input type="radio"/>							
FOTPLATTA HEL BEN 135-255	106968-99-0			<input type="radio"/>							
Knästopp											
KNÄSTOPP CORPUS VS	107038-99-0			<input checked="" type="checkbox"/>							

Sits Tillbehör						
Nackstöd						
NACKSTÖD TYG CORPUS 3G	106336-99-0	<input type="radio"/>				
NACKSTÖD SKAI CORPUS 3G	106331-99-0	<input type="radio"/>				
NACKSTÖD ERGO TYG C3G	106333-99-0	<input type="radio"/>				
NACKSTÖD ERGO CORPUS 3G	106332-99-0	<input type="radio"/>				
NACKSTÖD 340x130 ARM 325	107716-99-0	<input type="radio"/>				
NACKSTÖD 340x130 ARM 325LÄG RYGG	107715-99-0	<input type="radio"/>				
NACKSTÖD 340x130 ARM 240	107718-99-0	<input type="radio"/>				
NACKSTÖD 340x130 ARM 240LÄG RYGG	107717-99-0	<input type="radio"/>				
NACKSTÖD 250x125 ARM 325	107708-99-0	<input type="radio"/>				
NACKSTÖD 250x125 ARM 325LÄG RYGG	107719-99-0	<input type="radio"/>				
NACKSTÖD 250x125 ARM 240	107710-99-0	<input type="radio"/>				
NACKSTÖD 250x125 ARM 240LÄG RYGG	107709-99-0	<input type="radio"/>				
NACKSTÖD 180x110 ARM 325	107712-99-0	<input type="radio"/>				
NACKSTÖD 180x110 ARM 325LÄG RYGG	107711-99-0	<input type="radio"/>				
NACKSTÖD 180x110 ARM 240	107714-99-0	<input type="radio"/>				
NACKSTÖD 180x110 ARM 240LÄG RYGG	107713-99-0	<input type="radio"/>				
Bålstöd						
BÅLSTÖD TYG mod A 150x140VÄ C3G	107412-99-0	<input type="radio"/>				
BÅLSTÖD TYG mod F 225x90VÄ C3G	107414-99-0	<input type="radio"/>				
BÅLSTÖD TYG mod E 220x150VÄ C3G	107416-99-0	<input type="radio"/>				
BÅLSTÖD VÄ 180x130	107720-99-0	<input type="radio"/>				
BÅLSTÖD VÄ 130x80	107722-99-0	<input type="radio"/>				
BÅLSTÖD TYG mod A 150x140HÖ C3G	107413-99-0	<input type="radio"/>	<input type="radio"/>			
BÅLSTÖD TYG mod F 225x90HÖ C3G	107415-99-0	<input type="radio"/>	<input type="radio"/>			
BÅLSTÖD TYG mod E 220x150HÖ C3G	107417-99-0	<input type="radio"/>	<input type="radio"/>			
BÅLSTÖD HÖ 180x130	107721-99-0	<input type="radio"/>	<input type="radio"/>			
BÅLSTÖD HÖ 130x80	107723-99-0	<input type="radio"/>	<input type="radio"/>			
Lårstöd						
LÅRSTÖD TYG mod B 110x90VÄ	107392-99-0	<input type="radio"/>				
LÅRSTÖD TYG mod J 165x120VÄ	107396-99-0	<input type="radio"/>				
LÅRSTÖD TYG mod C 200x90VÄ	107394-99-0	<input type="radio"/>				
LÅRSTÖD TYG mod G 300x95VÄ	107390-99-0	<input type="radio"/>				
LÅRSTÖD TYG mod B 110x90HÖ	107393-99-0	<input type="radio"/>	<input type="radio"/>			
LÅRSTÖD TYG mod J 165x120HÖ	107397-99-0	<input type="radio"/>	<input type="radio"/>			
LÅRSTÖD TYG mod C 200x90HÖ	107395-99-0	<input type="radio"/>	<input type="radio"/>			
LÅRSTÖD TYG mod G 300x95HÖ	107391-99-0	<input type="radio"/>	<input type="radio"/>			

Höftstöd						
HÖFTSTÖD TYG mod B 110x90VÄ	107400-99-0	<input type="radio"/>				<p>A: 150x140mm 107398-99-0 107399-99-0</p> <p>B: 90x110mm 107400-99-0 107401-99-0</p> <p>C: 200x90mm 107402-99-0 107403-99-0</p> <p>D: 200x200mm 107404-99-0 107405-99-0</p>
HÖFTSTÖD TYG mod A150x140 VÄ	107398-99-0	<input type="radio"/>				
HÖFTSTÖD TYG mod C 200x90VÄ	107402-99-0	<input type="radio"/>				
HÖFTSTÖD TYG mod D200x200 VÄ	107404-99-0	<input type="radio"/>				
HÖFTSTÖD TYG mod B 110x90HÖ	107401-99-0		<input type="radio"/>			
HÖFTSTÖD TYG mod A150x140 HÖ	107399-99-0		<input type="radio"/>			
HÖFTSTÖD TYG mod C 200x90HÖ	107403-99-0		<input type="radio"/>			
HÖFTSTÖD TYG mod D200x200 HÖ	107405-99-0		<input type="radio"/>			
Vadstöd						
VADSTÖD B 110x90 TYG	107210-99-0	<input type="radio"/>				<p>A: 150x140mm 106190-99-0</p> <p>B: 90x110mm 107210-99-0</p> <p>D: 200x200mm 106186-99-0</p> <p>H: 170x175mm 106188-99-0</p> <p>J: 165x120mm 107211-99-0</p>
VADSTÖD J 165x120 TYG	107211-99-0	<input type="radio"/>				
VADSTÖD A 150x140 TYGHD/VS	106190-99-0	<input type="radio"/>				
VADSTÖD H 170x175 TYGHD/VS	106188-99-0	<input type="radio"/>				
VADSTÖD D TYG 200x200HD/VS	106186-99-0	<input type="radio"/>				
Armbågsstöd och Armsidostöd						
ARMBÅGESTOPP ARMSTÖD VÄ	107838-99-0	<input type="checkbox"/>				<p>107840-99-0 107863-99-0 107864-99-0 107865-99-0</p> <p>107838-99-0 107839-99-0</p>
ARMBÅGESTOPP ARMSTÖD HÖ	107839-99-0		<input type="checkbox"/>			
SIDOSTÖD UTSIDA ARMSTÖDVÄ	107863-99-0	<input type="checkbox"/>				
SIDOSTÖD UTSIDA ARMSTÖDHÖ	107840-99-0		<input type="checkbox"/>			
SIDOSTÖD INSIDA ARMSTÖDVÄ	107865-99-0	<input type="checkbox"/>				
SIDOSTÖD INSIDA ARMSTÖDHÖ	107864-99-0		<input type="checkbox"/>			
Kil ryggstöd						
RYGGSTÖDSKIL 360 C 3G	105410-99-0	<input type="radio"/>				<p>36cm: 105410-99-0 41cm: 105411-99-0 46cm: 105412-99-0 51cm: 105854-99-0</p>
RYGGSTÖDSKIL 410 C 3G	105411-99-0	<input type="radio"/>				
RYGGSTÖDSKIL 460 C 3G	105412-99-0	<input type="radio"/>				
RYGGSTÖDSKIL 510 C3G	105854-99-0	<input type="radio"/>				
Knästopp						
KNÄSTOPPHÅLLARE UNITRACK	107028-99-0	<input type="checkbox"/>				<p>107028-99-0</p>
Svankstöd						
SVANKSTÖD UPPBLÅSBART	101972-99-0	<input type="checkbox"/>				

Bälte					
UNIVERSALBAND BODYPOINTELASTISK LARGE 100mm	105843-99-0	<input type="radio"/>			
UNIVERSALBAND BODYPOINTELASTISK SMALL 75mm	105845-99-0	<input type="radio"/>			
BÄLTE SNÄPPLÅS	100518-99-0	<input type="radio"/>			
BÄLTE 2-PUNKT BODYPOINT50x1650 INKL FÄSTE	104514-99-0	<input type="radio"/>			
BÄLTE 2-PUNKT BODYPOINT50x1650 POLST. INKL FÄSTE	104516-99-0	<input type="radio"/>			
BÄLTE 2-PUNKT BODYPOINT38x1520 INKL FÄSTE	104518-99-0	<input type="radio"/>			
BÄLTE 2-PUNKT BODYPOINT38x1520 POLST. INKL FÄSTE	104520-99-0	<input type="radio"/>			
BÄLTE 2-PUNKT BODYPOINT50x1900 POLST INKL FÄSTE	106531-99-0	<input type="radio"/>			
BÄLTE FYRPOINT CORPUS	100529-99-0	<input type="radio"/>			
FOTREMSATS POLSTRAD	103104-99-0	<input type="radio"/>			
FOTREMSATS UTAN POLSTRING	103427-99-0	<input type="radio"/>			



Alternativa Sitsdynor					
INKONTINENSSKYDD		<input type="radio"/>			
SITSDYNA ERGO AIR		<input type="radio"/>			
ROHO QUADRO SELECT		<input type="radio"/>			
ROHO CONTOUR		<input type="radio"/>			
ROHO HYBRID ELITE		<input type="radio"/>			

Bord					
BORD SVÄNGBART SIDOUTTAGR-NET C 3G 600	105262-99-0	<input type="radio"/>	<input type="radio"/>		
BORD SVÄNGBART SIDOUTTAGR-NET C 3G 650	105263-99-0	<input type="radio"/>	<input type="radio"/>		
BORD SVÄNGBART CENTRUM-MONT R-NET C 3G 600	105264-99-0	<input type="radio"/>	<input type="radio"/>		
BORD SVÄNGBART CENTRUM-MONT R-NET C 3G 650	105261-99-0	<input type="radio"/>	<input type="radio"/>		
BORD JUSTERBART 450mmC 3G	105220-99-0	<input type="radio"/>			
BORD JUSTERBART 350 ARMSTMONT C3G	105221-99-0	<input type="radio"/>			
BORD JUSTERBART 400mmC 3G	105222-99-0	<input type="radio"/>			
BORD VINKELSTÄLLBART RAMMONT	106863-99-0	<input type="radio"/>			
BORD LITET VÄNSTER C 3G	105686-99-0	<input type="radio"/>			
BORD LITET HÖGER C 3G	105831-99-0		<input type="radio"/>		

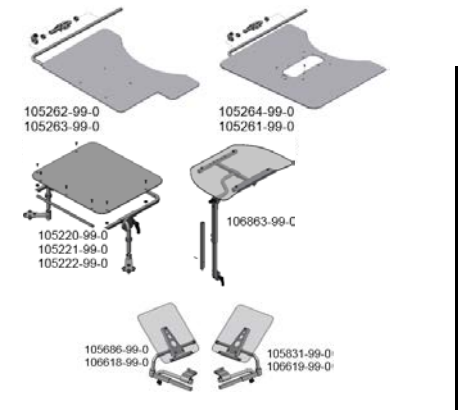

















Väska					
ARMSTÖDSVÄSKA HÖ SVART	107339-99-0	<input type="checkbox"/>	<input type="checkbox"/>		
ARMSTÖDSVÄSKA VÄ SVART	107338-99-0	<input type="checkbox"/>			
VÄSKKROKAR ÖPPNA UNITRACK	105563-99-0	<input type="checkbox"/>			
RYGGBOX CII C3G	102059-99-0	<input type="checkbox"/>			



Övriga tillbehör sits						
STÖDHANDTAG ARMSTÖDUNITRACK	106058-99-0	<input type="checkbox"/>	<input type="checkbox"/>			
STÖDHANDTAGSSATS (par)C 3G	105260-99-0	<input type="checkbox"/>				
PÅSKJUTSHANDTAG C 3G	105292-99-0	<input type="checkbox"/>				
PÅSKJUTSHANDTAG C3G SMALTRYGGSTÖD	105795-99-0	<input type="checkbox"/>				
MUGGHÅLLARE BALANSERAD	106210-99-0	<input type="checkbox"/>				
TELEFON HÅLLARE X-GREPPMED FÄSTE	106806-99-0	<input type="checkbox"/>				
SURFPLATTEHÅLLARE X-GRIPMED FÄSTE	106972-99-0	<input type="checkbox"/>				
Styrssystem						
Styrssystem						
MANÖVERPANEL FÄRG 3,5"R-NET	107159-99-0	<input checked="" type="checkbox"/>				
MANÖVERPANEL FÄRG 3,5"MED BLUETOOTH R-NET	107779-99-0	<input type="checkbox"/>				
MANÖVERPANEL LED R-NET	105246-99-0	<input type="checkbox"/>				
MANÖVERPANEL FÄRG 2,3"KRAFTIG JOYSTICK R-NET	105700-99-0	<input type="checkbox"/>				
MANÖVERPANEL KOMPAKT ADVR-NET	103814-99-0	<input type="checkbox"/>				
UTAN MANÖVERPANEL	101352-99-0	<input type="checkbox"/>				
Panelhållare						
PANELHÅLLARE PLGUNITRACK	107754-99-0	<input type="checkbox"/>	<input checked="" type="checkbox"/>			
PANELHÅLLARE R-NETTILL 250/300 ARMSTÖD	103473-99-0	<input type="checkbox"/>	<input type="checkbox"/>			
PANELHÅLLARE R-NETTILL 300/400 ARMSTÖD	103474-99-0	<input type="checkbox"/>	<input type="checkbox"/>			
UTAN PANELHÅLLARE	102835-99-0	<input type="checkbox"/>				
Panelhållare justerbar höjd						
PANELFÄSTE HÖJDJUSTERBARTHÖ	107960-99-0	<input type="checkbox"/>				
PANELFÄSTE HÖJDJUSTERBARTVÄ	107963-99-0	<input type="checkbox"/>				
PANELFÄSTE HÖJDJUSTERBARTKLÄMFÄSTE	108005-99-0	<input type="checkbox"/>				
Knapplåda						
KNAPPLÅDA VIPPARMAR	102799-99-0	<input type="checkbox"/>				
KNAPPLÅDA TRYCKKNAPPAR	102798-99-0	<input checked="" type="checkbox"/>				
UTAN KNAPPLÅDA ICS/R-NET	104621-99-0	<input type="checkbox"/>				
Fäste knapplåda						
FÄSTE KNAPPLÅDA PANEL	103469-99-0	<input checked="" type="checkbox"/>				
FÄSTE KNAPPLÅDA UNITRAC/ARMSTÖD	104651-99-0	<input type="checkbox"/>	<input type="checkbox"/>			
FÄSTE KNAPPLÅDA ICS RYGGCORPUS 3G	106256-99-0	<input type="checkbox"/>	<input type="checkbox"/>			
KNAPPLÅDA EJ MONTERAD	105409-99-0	<input type="checkbox"/>				

Layout knapplåda						
LAYOUT A KNAPPLÅDA	103744-99-0	<input checked="" type="radio"/>				 (A) 103744-99-0
LAYOUT B KNAPPLÅDA MEMO	103786-99-0	<input type="radio"/>				 (B) 103786-99-0
LAYOUT C KNAPPLÅDA MEMO	103787-99-0	<input type="radio"/>				 (C) 103787-99-0
LAYOUT D KNAPPLÅDA	103745-99-0	<input type="radio"/>				 (D) 103745-99-0
LAYOUT "E" KNAPPLÅDA	103788-99-0	<input type="radio"/>				 (E) 103788-99-0
LAYOUT "F" KNAPPLÅDA MEMO	103789-99-0	<input type="radio"/>				 (F) 103789-99-0
LAYOUT "G" KNAPPLÅDA MEMO	103790-99-0	<input type="radio"/>				 (G) 103790-99-0
LAYOUT L KNAPPLÅDA	105832-99-0	<input type="radio"/>				 (L) 105832-99-0
Nivåindikering knapplåda						
INDIKERING 1-KNAPPLÅDAINGET LJUS	103746-99-0	<input type="radio"/>				
INDIKERING 2-KNAPPLÅDAENDAST GRÖNA LJUS	103747-99-0	<input type="radio"/>				
INDIKERING 3-KNAPPLÅDAENDAST FAST LYSANDE	103748-99-0	<input type="radio"/>				
INDIKERING 4-KNAPPLÅDAALLA LJUS	103749-99-0	<input checked="" type="radio"/>				
Ladduttag externt						
LADDUTTAG MONTERATTILLBEHÖRSSKENA	104164-99-0	<input type="radio"/>	<input type="radio"/>			
LADDUTTAG MONTERATSITSRAM	104165-99-0	<input type="radio"/>	<input type="radio"/>			
Alternativa Joystickgrepp <input type="checkbox"/>						
JOYSTICKGREPP TRATT	100960-99-0	<input type="radio"/>				
JOYSTICKGREPP T	100961-99-0	<input type="radio"/>				
JOYSTICKGREPP KULA 38 MM	100962-99-0	<input type="radio"/>				
JOYSTICKGREPP BOLL 70 MM	100963-99-0	<input type="radio"/>				
JOYSTICKGREPP SVAMP	100964-99-0	<input type="radio"/>				
JOYSTICKGREPP PINNE	100965-99-0	<input type="radio"/>				
JOYSTICKGREPP KULA 30 MM	101165-99-0	<input type="radio"/>				
JOYSTICKGREPP STANDARD	101166-99-0	<input type="radio"/>				
JOYSTICKGREPP SOFTBALLSVART MED KONA	105442-99-0	<input type="radio"/>				
JOYST.GREPP U-FORM 76mmBODYPOINT	105846-99-0	<input type="radio"/>				
JOYST.GREPP U-FORM 100mmBODYPOINT	105847-99-0	<input type="radio"/>				
JOYST.GEPP GUMMIKUPOLBODYPOINT	105848-99-0	<input type="radio"/>				
Vårdarstyrning						
VÅRDARSTYRNING CO-PILOT2 FÖR CORPUS/C3G	107809-99-0	<input type="radio"/>				
VÅRDARSTYRNING R-NET INKL PANEL FÄRG 3,5"	107318-99-0	<input type="radio"/>	<input type="radio"/>			
VÅRDARSTYRNING R-NET INKL PANEL LED	107320-99-0	<input type="radio"/>	<input type="radio"/>			
VÅRDARSTYRNING R-NET INKL VÅRDAR PANEL	107321-99-0	<input type="radio"/>	<input type="radio"/>			
VÅRDARSTYRNING FORUS INKL FÄSTE C3G	106933-99-0	<input type="radio"/>				
Nödstop						
NÖDSTOPP CO-PILOT	101792-99-0	<input type="checkbox"/>				
PermoLock						
PERMOLOCK C3	104022-99-0	<input type="checkbox"/>				
FRIGÖRINGSHANDTAG EXTERNTPERMOLOCK C	102841-99-0	<input type="checkbox"/>				
SNABBLÅSFÄSTE HANDTAGPERMOLOCK C	102859-99-0	<input type="checkbox"/>				
DISTANS PERMOLOCK C	102864-99-0	<input type="checkbox"/>				
MONTERINGSSATS SNAP IN	101411-99-0	<input type="checkbox"/>				
SITSADAPTER PERMOLOCK C3	104708-99-0	<input type="checkbox"/>				
LÄGESRIKTARE (fordon)	104707-99-0	<input type="checkbox"/>				
KABLAGE FÖRLÄNGNING 2000PERMOLOCK C C3	104232-99-0	<input type="checkbox"/>				
						
Extra tillbehör						
Extra tillbehör						
JOYSTICK COMPACT LIGHTR-NET	103892-99-0	<input type="radio"/>				

JOYSTICK KOMPAKT R-NET	103817-99-0	<input type="radio"/>						
MINIJOYSTICK R-NET	105289-99-0	<input type="radio"/>				103817-99-0	103892-99-0	105289-99-0
OMK.SATS KOMPAKT JOYSTP+ R-NET OMNI	104641-99-0	<input type="checkbox"/>						
PANELHÅLL.FÄSTE EXTRAC 3G	105210-99-0	<input type="checkbox"/>				101303-99-0	107367-99-0 107368-99-0 107350-99-0	107359-99-0
BRÖSTSTÖD CORPUS	101303-99-0	<input type="checkbox"/>				101303-99-0	107367-99-0 107368-99-0 107350-99-0	107359-99-0
MUSSTYRNING 1 BLUETOOTHUNITRAC	107367-99-0	<input type="checkbox"/>						
MUSSTYRNING 2 BLUETOOTHUNITRAC	107368-99-0	<input type="checkbox"/>				107367-99-0 107368-99-0 107350-99-0	107367-99-0 107368-99-0 107350-99-0	107359-99-0
MUSSTYRNING BLUETOOTHIDEVICE UNITRAC	107350-99-0	<input type="checkbox"/>				107367-99-0 107368-99-0 107350-99-0	107367-99-0 107368-99-0 107350-99-0	107359-99-0
KABLAGEADAPTER KNAPPMUSSTYRNING	107359-99-0	0	▼			107189-99-0	104641-99-0	101766-99-0 101767-99-0 101768-99-0
USB LADDARE CORPUS/CORPUS VS	107189-99-0	<input type="radio"/>	<input type="radio"/>			107189-99-0	104641-99-0	101766-99-0 101767-99-0 101768-99-0
OMKOPPLARE BUDDY BUTTON63 MM SVART	101766-99-0	0	▼					
OMKOPPLARE BUDDY BUTTON63 MM RÖD	101767-99-0	0	▼			101769-99-0	101771-99-0	101770-99-0
OMKOPPLARE BUDDY BUTTON63 MM GUL	101768-99-0	0	▼			101769-99-0	101771-99-0	101770-99-0
OMKOPPLARE MICRO LIGHT	101769-99-0	0	▼					
OMKOPPLARE CUP	101770-99-0	0	▼			101772-99-0	104696-99-0	104196-99-0
OMKOPPLARE MINI CUP	101771-99-0	0	▼			101772-99-0	104696-99-0	104196-99-0
OMKOPPLARE GRASP	101772-99-0	0	▼				104696-99-0	104196-99-0
KNAPPLÅDA ALTERNATIV ICS8 INGÅNGAR	104196-99-0	<input type="checkbox"/>				105210-99-0		
KNAPP INTERFACE R-NET	104696-99-0	<input type="checkbox"/>						