

Utprovningsprotokoll

Etac Cross 5

Gäller från 28 juni 2018



Etac Cross 5

Standard är markerat med X

Utprovad av: _____

Brukare: _____

Telefon: _____

Datum: _____

Artikel nr	Sitsbredd	Sitslängd	Sitsdjup	
13123001	35 cm	Kort	36-42 cm	<input type="checkbox"/>
13123002	35 cm	Lång	42-48 cm	<input type="checkbox"/>
13123003	37.5 cm	Kort	36-42 cm	<input type="checkbox"/>
13123004	37.5 cm	Lång	42-48 cm	<input type="checkbox"/>
13123005	40 cm	Kort	36-42 cm	<input type="checkbox"/>
13123006	40 cm	Lång	42-48 cm	<input type="checkbox"/>
13123007	42.5 cm	Kort	36-42 cm	<input type="checkbox"/>
13123008	42.5 cm	Lång	42-48 cm	<input type="checkbox"/>
13123009	45 cm	Kort	36-42 cm	<input type="checkbox"/>
13123010	45 cm	Lång	42-48 cm	<input type="checkbox"/>
13123011	47.5 cm	Kort	36-42 cm	<input type="checkbox"/>
13123012	47.5 cm	Lång	42-48 cm	<input type="checkbox"/>
13123013	50 cm	Kort	36-42 cm	<input type="checkbox"/>
13123014	50 cm	Lång	42-48 cm	<input type="checkbox"/>

Chassifärg

93 Mörkblå

Etac Cross 5

Standard är markerat med X
Standard och tillval Cross 5

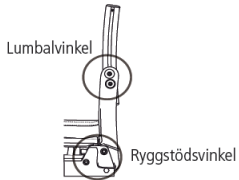
Artikel			Artikel nr	
Ryggstöd Cross 3A		Triangulär	-8° – +18°	<input checked="" type="checkbox"/>
Rygg	3A standard 3A hög			<input checked="" type="checkbox"/> <input type="checkbox"/>
Klädsel rygg	Standard reglerbar	35-40 cm	62953-60	<input checked="" type="checkbox"/>
		42.5-50 cm	62954-60	<input checked="" type="checkbox"/>
	Hög reglerbar	35-40 cm	63014-60	<input type="checkbox"/>
		42.5-50 cm	63015-60	<input type="checkbox"/>
Överdrag rygg	Standard	35 cm	62941-60	<input checked="" type="checkbox"/>
		37.5 cm	62942-60	<input checked="" type="checkbox"/>
		40 cm	62943-60	<input checked="" type="checkbox"/>
		42.5 cm	62944-60	<input checked="" type="checkbox"/>
		45 cm	62945-60	<input checked="" type="checkbox"/>
		47.5 cm	62946-60	<input checked="" type="checkbox"/>
		50 cm	62947-60	<input checked="" type="checkbox"/>
	Komfort	35 cm	62956-60	<input type="checkbox"/>
		37.5 cm	62957-60	<input type="checkbox"/>
		40 cm	62958-60	<input type="checkbox"/>
		42.5 cm	62959-60	<input type="checkbox"/>
		45 cm	62960-60	<input type="checkbox"/>
		47.5 cm	62961-60	<input type="checkbox"/>
		50 cm	62962-60	<input type="checkbox"/>
	Hög rygg standard	35 cm	63020-60	<input type="checkbox"/>
		37.5 cm	63021-60	<input type="checkbox"/>
		40 cm	63022-60	<input type="checkbox"/>
		42.5 cm	63023-60	<input type="checkbox"/>
		45 cm	63024-60	<input type="checkbox"/>
		47.5 cm	63025-60	<input type="checkbox"/>
		50 cm	63026-60	<input type="checkbox"/>
Hög rygg komfort	35 cm	63033-60	<input type="checkbox"/>	
	37.5 cm	63034-60	<input type="checkbox"/>	
	40 cm	63035-60	<input type="checkbox"/>	
	42.5 cm	63036-60	<input type="checkbox"/>	
	45 cm	63037-60	<input type="checkbox"/>	
	47.5 cm	63038-60	<input type="checkbox"/>	
	50 cm	63039-60	<input type="checkbox"/>	

Etac Cross 5

Standard är markerat med X

Airmesh	35 cm	63204-68	<input type="checkbox"/>
	37.5 cm	63205-68	<input type="checkbox"/>
	40 cm	63206-68	<input type="checkbox"/>
	42.5 cm	63207-68	<input type="checkbox"/>
	45 cm	63208-68	<input type="checkbox"/>
	47.5 cm	63209-68	<input type="checkbox"/>
	50 cm	63210-68	<input type="checkbox"/>
Tidy	35 cm	63087-63	<input type="checkbox"/>
	37.5 cm	63088-63	<input type="checkbox"/>
	40 cm	63089-63	<input type="checkbox"/>
	42.5 cm	63090-63	<input type="checkbox"/>
	45 cm	63091-63	<input type="checkbox"/>
	47.5 cm	63092-63	<input type="checkbox"/>
	50 cm	63093-63	<input type="checkbox"/>
Tidy, brodyr utan logga	35 cm	63108-63	<input type="checkbox"/>
	37.5 cm	63109-63	<input type="checkbox"/>
	40 cm	63110-63	<input type="checkbox"/>
	42.5 cm	63111-63	<input type="checkbox"/>
	45 cm	63112-63	<input type="checkbox"/>
	47.5 cm	63113-63	<input type="checkbox"/>
	50 cm	63114-63	<input type="checkbox"/>
Tidy, brodyr med logga	35 cm	63119-63	<input type="checkbox"/>
	37.5 cm	63120-63	<input type="checkbox"/>
	40 cm	63121-63	<input type="checkbox"/>
	42.5 cm	63122-63	<input type="checkbox"/>
	45 cm	63123-63	<input type="checkbox"/>
	47.5 cm	63124-63	<input type="checkbox"/>
	50 cm	63125-63	<input type="checkbox"/>



Rygg höjd	3A std, justerbar 32-45 cm	Ange rygg höjd: _____
	Standard 40 cm	
	3A hög, justerbar 38-51 cm	Ange rygg höjd: _____
	Standard 46 cm	

Ryggvinkel	Justerbar -5- +15 grader	0 gr	<input type="checkbox"/>
		+2 gr	<input checked="" type="checkbox"/>
		+5 gr	<input type="checkbox"/>
Standard +2 gr = 92 gr mellan sits och rygg			

Broms		med vinklat rött handtag	höger	27528-1	<input checked="" type="checkbox"/>
			vänster	27528-2	<input checked="" type="checkbox"/>

Etac Cross 5

Standard är markerat med X

	med vinklat svart handtag	höger	27532-1	<input type="checkbox"/>
		vänster	27532-2	<input type="checkbox"/>
	med förlängt handtag fällbart	höger	27530-1	<input type="checkbox"/>
		vänster	27530-2	<input type="checkbox"/>
	Enhandsbroms kompl	höger	27531-1	<input type="checkbox"/>
		vänster	27531-2	<input type="checkbox"/>







Etac Cross 5

Standard är markerat med X

Benstöd				
	Vid vinkel svarta		25574-01	<input checked="" type="checkbox"/>
	Snäv vinkel		25570-01	<input type="checkbox"/>
	Snäv vinkel korta		25571-01	<input type="checkbox"/>
	Vid vinkel	låsbara	25575-01	<input type="checkbox"/>
	Snäv vinkel	låsbara	25573-01	<input type="checkbox"/>
	Vinkelreglerbart mod 1 exkl vadplatta		25660-01	<input type="checkbox"/>
	Vinkelreglerbart mod 3 exkl vadplatta		27149	<input type="checkbox"/>
	Dynkonsol för vadplatta		24544-01	<input type="checkbox"/>
	Dynkonsol FlipUp för vadplatta		27322-01	<input type="checkbox"/>
	Vadplatta mörkgrå	35-37.5 cm	62105-60	<input type="checkbox"/>
		40-42.5 cm	62104-60	<input type="checkbox"/>
		45-47.5 cm	62484-60	<input type="checkbox"/>
		50 cm	62451-60	<input type="checkbox"/>
	Vinkelreglerbart mod 2 inkl uppfällbar vadplatta	höger	25567-1	<input type="checkbox"/>
		vänster	25567-2	<input type="checkbox"/>
	Vinkelreglerbart mod 3 inkl uppfällbar vadplatta	höger/vänster	26100	<input type="checkbox"/>
	Vinkelreglerbart Prio inkl vadplatta grå hygien	42.5-45 cm höger	27857-65-1	<input type="checkbox"/>
		vänster	27857-65-2	<input type="checkbox"/>
		47.5-50 cm höger	27858-65-1	<input type="checkbox"/>
		vänster	27858-65-2	<input type="checkbox"/>
	Gipsbenstöd inkl tre dynor	höger	27417-1	<input type="checkbox"/>
		vänster	27417-2	<input type="checkbox"/>
	Amputationsbenstöd	mörkgrå plysch	25516-60	<input type="checkbox"/>
		svart Dartex	25516-63	<input type="checkbox"/>
	Amputationsvikt kompl		26876	<input type="checkbox"/>

Etac Cross 5

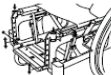
Standard är markerat med X

Fotplattor     	Delade uppfällbara Reglerbar höjd, justerbar vinkel och djup	35 cm 37.5 cm 40 cm 42.5 cm 45 cm 47.5 cm 50 cm	25641-1/2 25642-1/2 25643-1/2 25644-1/2 25645-1/2 25736-1/2 25646-1/2	<input checked="" type="checkbox"/> <input checked="" type="checkbox"/> <input checked="" type="checkbox"/> <input checked="" type="checkbox"/> <input checked="" type="checkbox"/> <input checked="" type="checkbox"/> <input checked="" type="checkbox"/>	
	Delade uppfällbara som ovan med längre infästningsrör +10 cm	35 cm 37.5 cm 40 cm 42.5 cm 45 cm 47.5 cm 50 cm	25647-1/2 25648-1/2 25649-1/2 25650-1/2 25651-1/2 25737-1/2 25652-1/2	<input type="checkbox"/> <input type="checkbox"/> <input type="checkbox"/> <input type="checkbox"/> <input type="checkbox"/> <input type="checkbox"/> <input type="checkbox"/>	
	Delade uppfällbara som ovan med kortare infästningsrör -8 cm	35 cm 37.5 cm 40 cm 42.5 cm 45 cm 47.5 cm 50 cm	25653-1/2 25654-1/2 25655-1/2 25656-1/2 25657-1/2 25738-1/2 25658-1/2	<input type="checkbox"/> <input type="checkbox"/> <input type="checkbox"/> <input type="checkbox"/> <input type="checkbox"/> <input type="checkbox"/> <input type="checkbox"/>	
	Hel fotplatta kompl	35-37.5 cm 40-50 cm	25936 25937	<input type="checkbox"/> <input type="checkbox"/>	
	Hel fotplatta barn kompl	35 cm 37.5 cm	26306 26307	<input type="checkbox"/> <input type="checkbox"/>	
	Hälband 	Till delade fotplattor	hö/vä	24458	<input type="checkbox"/>
	Drivhjul snabbkopplande med drivring	Högtrycksdäck med drivring: Aluminium Cellgummi Plastad Rostfri Aluminium Cellgummi Plastad Rostfri Titan	22" 22" 22" 22" 24" 24" 24" 24" 24"	27547 27548 27549 27550 27558 27559 28064 27561 27562	<input type="checkbox"/> <input type="checkbox"/> <input type="checkbox"/> <input type="checkbox"/> <input checked="" type="checkbox"/> <input type="checkbox"/> <input type="checkbox"/> <input type="checkbox"/>

Etac Cross 5

Standard är markerat med X

Lågtrycksdäck med drivring:

Aluminium	20"	27537	<input type="checkbox"/>
Cellgummi	20"	27538	<input type="checkbox"/>
Plastad	20"	27539	<input type="checkbox"/>
Rostfri	20"	27540	<input type="checkbox"/>

Massivt däck med drivring:

Aluminium	20"	27542	<input type="checkbox"/>
Cellgummi	20"	27543	<input type="checkbox"/>
Rostfri	20"	27544	<input type="checkbox"/>
Aluminium	22"	27552	<input type="checkbox"/>
Cellgummi	22"	27553	<input type="checkbox"/>
Plastad	22"	27554	<input type="checkbox"/>
Rostfri	22"	27555	<input type="checkbox"/>
Aluminium	24"	27564	<input type="checkbox"/>
Cellgummi	24"	27565	<input type="checkbox"/>
Plastad	24"	27566	<input type="checkbox"/>
Rostfri	24"	27567	<input type="checkbox"/>

Lättviktshjul carbon med drivring:

Plastad	24"	82555	<input type="checkbox"/>
Titan	24"	82534	<input type="checkbox"/>

Axel QR 12 mm

82483

Axel QR 11.9 mm (lättviktshjul carbon)

82581

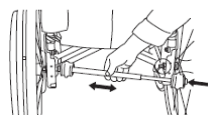

Enarmsdrift drivenhet

24"

26522

fast nav

22"

26533

20"

26534

Teleskopaxel enarmsdrift

35/37,5 cm

27317

40/42,5 cm

27318

45/47,5/50 cm

27319

Länkhjul

100 x 30 massivt (max brukarvikt 100 kg)

4"

27870

125 x 30 massivt

5"

27865

165 x 30 massivt

6.5"

27866

Framgaffel

Kort

24677

stålaxel

Medium

24678

Kort för 4" länkhjul

26238

Etac Cross 5

Standard är markerat med X

Framgaffelfäste	Standard	28147	<input checked="" type="checkbox"/>
För extra låg sitthöjd	Lågt	28175	<input type="checkbox"/>
Ger utökat sparkutrymme	Breddat	25763	<input type="checkbox"/>

Camberbricka	2°	bricka yttre 2 st	82567	<input checked="" type="checkbox"/>
		bricka inre 2 st	82568	<input checked="" type="checkbox"/>
	0°	bricka yttre 2 st	82569	<input type="checkbox"/>
		bricka inre 2 st	82570	<input type="checkbox"/>

Sitshöjd bak	Drivhjulposition	20" pos G	34 cm	<input type="checkbox"/>
		20" pos F	36 cm	<input type="checkbox"/>
		20" pos E	38 cm	<input type="checkbox"/>
		20" pos D	40 cm	<input type="checkbox"/>
		20" pos C	42 cm	<input type="checkbox"/>
		20" pos B	44 cm	<input type="checkbox"/>
		20" pos A	46 cm	<input type="checkbox"/>

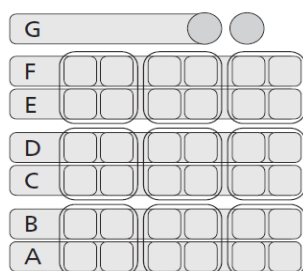
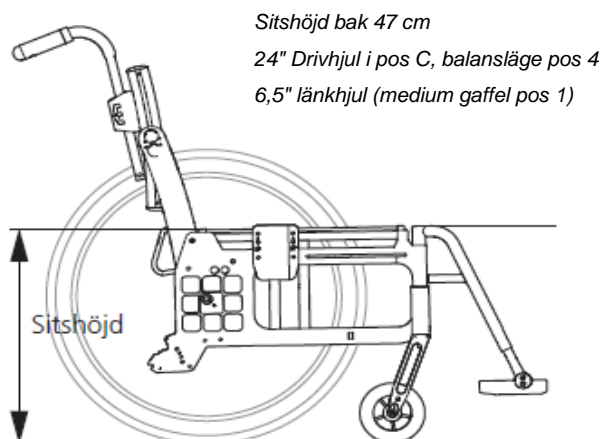

22" pos G	36.5 cm	<input type="checkbox"/>
22" pos F	38.5 cm	<input type="checkbox"/>
22" pos E	40.5 cm	<input type="checkbox"/>
22" pos D	42.5 cm	<input type="checkbox"/>
22" pos C	44.5 cm	<input type="checkbox"/>
22" pos B	46.5 cm	<input type="checkbox"/>
22" pos A	48.5 cm	<input type="checkbox"/>

24" pos G	39 cm	<input type="checkbox"/>
24" pos F	41 cm	<input type="checkbox"/>
24" pos E	43 cm	<input type="checkbox"/>
24" pos D	45 cm	<input type="checkbox"/>
24" pos C	47 cm	<input checked="" type="checkbox"/>
24" pos B	49 cm	<input type="checkbox"/>
24" pos A	51 cm	<input type="checkbox"/>

* 26" drivhjul beställs separat
Se reservdelar

* 26" pos F	43 cm	<input type="checkbox"/>
* 26" pos E	45 cm	<input type="checkbox"/>
* 26" pos D	47 cm	<input type="checkbox"/>
* 26" pos C	49 cm	<input type="checkbox"/>
* 26" pos B	51 cm	<input type="checkbox"/>
* 26" pos A	53 cm	<input type="checkbox"/>

Etac Cross 5

Standard är markerat med X

Sitshöjd fram

Framgaffelposition

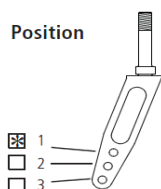

Länkhjul / Framgaffel

4" / extra kort

5" / kort

6,5" / kort

5" / medium

6,5" / medium

6,5" / lång*

8" * / medium

8" * / lång*

* 8" länkhjul och lång gaffel

beställs separat. Se reservdelar

höjd 34-39.5 cm

höjd 36-44.5 cm

höjd 41-46.5 cm

höjd 43-49 cm

höjd 46-51 cm (std 47cm)

höjd 50.5-55.5 cm

höjd 48-52 cm

höjd 52.5-56.5 cm

Ange höjd

_____ cm

_____ cm

_____ cm

_____ cm

_____ cm

X

Balansläge

Standard pos 4

Alternativa sitshöjder/sitsvinklar

Se tabell i manual Cross

Välj balansläge 1-6 _____

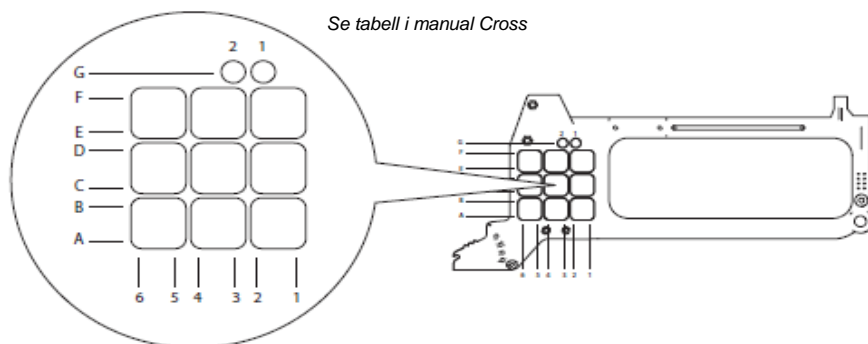

Klädsel sits

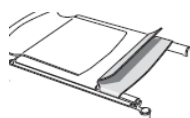

Svart tyg, reglerbar i djup

Basic kort (kort sitsdjup)

35 cm

62718-60

X

37.5 cm

62719-60

X

40 cm

62720-60

X

42.5 cm

62721-60

X

45 cm

62722-60

X

47.5 cm

62978-60

X

50 cm

62979-60

X

Basic lång (långt sitsdjup)

35 cm

62728-60

X

37.5 cm

62729-60

X

40 cm

62730-60

X

42.5 cm

62731-60

X

45 cm

62732-60

X

47.5 cm

62984-60

X

50 cm

62985-60

X

Etac Cross 5

Standard är markerat med X

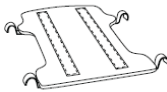
Hård sits					
	kort sitsdjup	35-37.5 cm	26720	<input type="checkbox"/>	
		40-42.5 cm	26721	<input type="checkbox"/>	
		45-47.5 cm	26722	<input type="checkbox"/>	
		50 cm	26723	<input type="checkbox"/>	
	långt sitsdjup	35-37.5 cm	26725	<input type="checkbox"/>	
		40-42.5 cm	26726	<input type="checkbox"/>	
		45-47.5 cm	26727	<input type="checkbox"/>	
		50 cm	26728	<input type="checkbox"/>	

Sitsförlängare klädsel				
Crossrygg mod 3		35-42,5 cm	62976	<input checked="" type="checkbox"/>
		45-60 cm	62977	<input checked="" type="checkbox"/>

Förlänger sitsen 7 cm i bakkant tillsammans med triangulär rygg









Körhandtag				
	Höjdregerbara	höger/vänster	27588-01	<input checked="" type="checkbox"/>

Körbygel				
Höjdregerbar 	Obs! En stl mindre än stolsbredd	Stolsbredd		
	32,5 cm	35 cm	27433-01	<input type="checkbox"/>
	35 cm	37.5 cm	25578-01	<input type="checkbox"/>
	37,5 cm	40 cm	25579-01	<input type="checkbox"/>
	40 cm	42.5 cm	25580-01	<input type="checkbox"/>
	42,5 cm	45 cm	25581-01	<input type="checkbox"/>
	45 cm	47.5 cm	25582-01	<input type="checkbox"/>
	47,5 cm	50 cm	25730-01	<input type="checkbox"/>

Körbygel				
Vinkelreglerbar 	Obs! En stl mindre än stolsbredd	Stolsbredd		
	35 cm	37.5 cm	27161	<input type="checkbox"/>
	37,5 cm	40 cm	27162	<input type="checkbox"/>
	40 cm	42.5 cm	27163	<input type="checkbox"/>
	42,5 cm	45 cm	27164	<input type="checkbox"/>
	45 cm	47.5 cm	27165	<input type="checkbox"/>
	47,5 cm	50 cm	27166	<input type="checkbox"/>

Etac Cross 5









Standard är markerat med X

Armstöd		kort med ingjuten massiv platta längd 25 cm höjddjusterbara	höger	25172-1	<input checked="" type="checkbox"/>
			vänster	25172-2	<input checked="" type="checkbox"/>
		lång med avtagbar armstödsdyna längd 25 cm höjddjusterbara	höger	27230-1	<input type="checkbox"/>
			vänster	27230-2	<input type="checkbox"/>
		lång med avtagbar armstödsdyna längd 38 cm höjddjusterbara	höger	25173-1	<input type="checkbox"/>
			vänster	25173-2	<input type="checkbox"/>
		lång med ingjuten massiv platta längd 35 cm höjddjusterbara	höger	27231-1	<input type="checkbox"/>
			vänster	27231-2	<input type="checkbox"/>
		Uppfällbara fasta <i>Finns restriktioner, se rullstolens manual</i>	höger	25551-1	<input type="checkbox"/>
			vänster	25551-2	<input type="checkbox"/>
		Uppfällbara höjddjusterbara <i>Finns restriktioner, se rullstolens manual</i>	höger	25546-1	<input type="checkbox"/>
			vänster	25546-2	<input type="checkbox"/>
		Stänkskärm svart	höger	27397-1	<input type="checkbox"/>
			vänster	27397-2	<input type="checkbox"/>
Tippskydd		Tippskydd teleskoperande	kompl	27526	<input checked="" type="checkbox"/>
Transportfäste		Transportfäste kompl	höger	82573	<input checked="" type="checkbox"/>
			vänster	82574	<input checked="" type="checkbox"/>

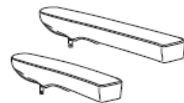
Etac Cross 5







Standard är markerat med X

Tillbehör Cross 5

Artikel				Artikel nr	
Lärstöd 	Monteras på korta alt. långa armstöd, komplett				
	<i>Passar ej med 22" drivhjul i pos. C1.</i>				
	<i>Passar ej med 24" drivhjul i pos. C1 eller B1.</i>				
	kort	höger		27391-1	<input type="checkbox"/>
	kort	vänster		27391-2	<input type="checkbox"/>
	lång	höger	27392-1	<input type="checkbox"/>	
	lång	vänster	27392-2	<input type="checkbox"/>	
Mjukdyna 		höger		82488-1	<input type="checkbox"/>
		vänster		82488-2	<input type="checkbox"/>
Tillbehör armstöd   	Armstödsdyna Hemi	höger		27313-60-1	<input type="checkbox"/>
	<i>(passar till 27231-1/2)</i>	vänster		27313-60-2	<input type="checkbox"/>
	Armstödsdyna Hemi	höger		25770-60-1	<input type="checkbox"/>
	<i>(passar till 25173-1/2)</i>	vänster		25770-60-2	<input type="checkbox"/>
	Armstödsdyna polstrad	kort antal: _____		62282-60	<input type="checkbox"/>
	mörkgrå plysch, 25 el 38 cm långt	lång antal: _____		62283-60	<input type="checkbox"/>
	<i>(passar till 25172-1/2 och 25173-1/2)</i>				
	Armstödsdyna Gel	kort antal: _____		26240-60	<input type="checkbox"/>
	mörkgrå plysch, 25 el 38 cm långt	lång antal: _____		26241-60	<input type="checkbox"/>
	<i>(passar till 25172-1/2 och 25173-1/2)</i>				
Armstödsdyna bred och mjuk	8x40 cm		26873	<input type="checkbox"/>	
<i>(passar till 25172-1/2 och 25173-1/2)</i>					
Fotplatta 	Förlängningsdel	40-42.5 cm	antal: _____	50798	<input type="checkbox"/>
	(Monteras på befintlig fotplatta)	45-47.5 cm	antal: _____	50799	<input type="checkbox"/>
		50 cm	antal: _____	50800	<input type="checkbox"/>
Polstring fotplattor  	Delade fotplattor	35 - 40	höger	63188-60-1	<input type="checkbox"/>
		35 - 40	vänster	63188-60-2	<input type="checkbox"/>
		42.5 - 50	höger	63189-60-1	<input type="checkbox"/>
		42.5 - 50	vänster	63189-60-2	<input type="checkbox"/>
		52.5 - 60	höger	63192-60-1	<input type="checkbox"/>
		52.5 - 60	vänster	63192-60-2	<input type="checkbox"/>
	Hel fotplatta	40 - 47.5		63190-60	<input type="checkbox"/>
		50 - 60		63191-60	<input type="checkbox"/>
Vadband 	Avtagbart och delbart	35-37.5 cm		25356	<input type="checkbox"/>
	nylon	40-42.5 cm		25357	<input type="checkbox"/>
		45-47.5 cm		25358	<input type="checkbox"/>
		50 cm		25359	<input type="checkbox"/>



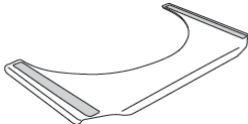

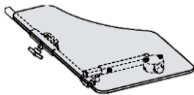
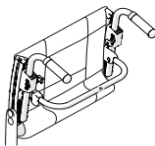

Etac Cross 5

Standard är markerat med X

Polstring för vadband		20 cm	26845	<input type="checkbox"/>	
		30 cm	26846	<input type="checkbox"/>	
		40 cm	26847	<input type="checkbox"/>	
Vadmatta		Plysch. Monteras/justeras med kardborre	75 cm	63186-60	<input type="checkbox"/>
			90 cm	63187-60	<input type="checkbox"/>
Överdrag vadplatta		till vrb benstöd 26100	Dartex	62762-63	<input type="checkbox"/>
Bord		Transparent, monteras på långa armstöd	35 cm	24417	<input type="checkbox"/>
			37.5 cm	25187	<input type="checkbox"/>
		Storlek=stolens bredd	40 cm	24418	<input type="checkbox"/>
			42.5 cm	25188	<input type="checkbox"/>
			45 cm	24419	<input type="checkbox"/>
			47.5 cm	25731	<input type="checkbox"/>
		50 cm	24601	<input type="checkbox"/>	
Hemibord		Transparent	35 cm kort överdrag	26556	<input type="checkbox"/>
		Storlek=stolens bredd	35 cm långt överdrag	26563	<input type="checkbox"/>
			37,5 cm kort överdrag	26557	<input type="checkbox"/>
			37,5 cm långt överdrag	26564	<input type="checkbox"/>
			40 cm kort överdrag	26558	<input type="checkbox"/>
			40 cm långt överdrag	26565	<input type="checkbox"/>
			42,5 cm kort överdrag	26559	<input type="checkbox"/>
			42,5 cm långt överdrag	26566	<input type="checkbox"/>
			45 cm kort överdrag	26560	<input type="checkbox"/>
			45 cm långt överdrag	26567	<input type="checkbox"/>
			47,5 cm kort överdrag	26561	<input type="checkbox"/>
			47,5 cm långt överdrag	26568	<input type="checkbox"/>
			50 cm kort överdrag	26562	<input type="checkbox"/>
	50 cm långt överdrag	26569	<input type="checkbox"/>		
		Halkskydd hemibord	81633	<input type="checkbox"/>	
Hemibord halvt Kommunikation		höger	27352-1	<input type="checkbox"/>	
		vänster	27352-2	<input type="checkbox"/>	
Fäste bord kompl		Rund infästning. Passar rör upp till 18 mm i diameter.	höger	27956-1	<input type="checkbox"/>
			vänster	27956-2	<input type="checkbox"/>
Tvärstag med snäpplåsning		Stolsbredd	35 cm	28114	<input type="checkbox"/>
			37.5 cm	28115	<input type="checkbox"/>
			40 cm	28116	<input type="checkbox"/>
			42.5 cm	28117	<input type="checkbox"/>
			45 cm	28118	<input type="checkbox"/>
			47.5 cm	28119	<input type="checkbox"/>
			50 cm	28120	<input type="checkbox"/>





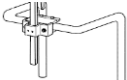
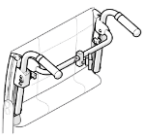



Etac Cross 5

Standard är markerat med X

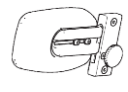
Sittdyna		Universal mörkgrå	35 cm	62230-60	<input type="checkbox"/>
		Mörkgrå plysch, 56 cm lång, anatomiskt formad, kapas till inställt sitsdjup.	37.5 cm 40 cm 42.5 cm 45 cm 47.5 cm 50 cm	62231-60 62232-60 62233-60 62234-60 62374-60 62266-60	<input type="checkbox"/> <input type="checkbox"/> <input type="checkbox"/> <input type="checkbox"/> <input type="checkbox"/> <input type="checkbox"/>
Tidy		Avtorkningsbar	35 cm	63130-63	<input type="checkbox"/>
			37.5 cm	63131-63	<input type="checkbox"/>
			40 cm	63132-63	<input type="checkbox"/>
			42.5 cm	63133-63	<input type="checkbox"/>
			45 cm	63134-63	<input type="checkbox"/>
			47.5 cm	63135-63	<input type="checkbox"/>
			50 cm	63136-63	<input type="checkbox"/>
Komfortkil sittdyna		Universal	35-37.5 cm	80714	<input type="checkbox"/>
			40-45 cm	80715	<input type="checkbox"/>
			47.5-50 cm	80779	<input type="checkbox"/>
Höftbälte		med snäplås, avkortbart.	100 cm	25668	<input type="checkbox"/>
Bälte		2 alternativa fästpunkter på ramen	128 cm	26163	<input type="checkbox"/>
		med snäplås, helt	170 cm	62190	<input type="checkbox"/>
Huvudstöd		Mod 4 hygien grå	260x140 mm	28223-65	<input type="checkbox"/>
		inkl stag. Mont på körbygel/tvärstag	Mod 4 mörkgrå plysch	260x140 mm	28223-60
		Huvudstöd med sidostöd <i>Reglerbara i höjd, djup, vinkel och sidledes</i>	hygien grå	28325-65	<input type="checkbox"/>
		Huvudstödsfäste för körbygel kompl		25795	<input type="checkbox"/>
		Huvudstödsfäste för tvärstag kompl	Stolsbredd		<input type="checkbox"/>
		Crossrygg 3A, mod 4	35 cm	28125	<input type="checkbox"/>
			37.5 cm	28126	<input type="checkbox"/>
			40 cm	28127	<input type="checkbox"/>
			42.5 cm	28128	<input type="checkbox"/>
			45 cm	28129	<input type="checkbox"/>
			47.5 cm	28130	<input type="checkbox"/>
			50 cm	28131	<input type="checkbox"/>

Etac Cross 5

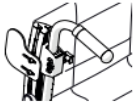
Standard är markerat med X

Bålstöd 	justerbart, sidosvängbart och avtagbart	0 mm hö	28181-1	<input type="checkbox"/>
		0 mm vä	28181-2	<input type="checkbox"/>
		-15 mm hö	28180-1	<input type="checkbox"/>
		-15 mm vä	28180-2	<input type="checkbox"/>
		-45 mm hö	28141-1	<input type="checkbox"/>
		-45 mm vä	28141-2	<input type="checkbox"/>
	justerbart och avtagbart	0 mm	Ange antal: _____ 28142	<input type="checkbox"/>
		+15 mm	Ange antal: _____ 28143	<input type="checkbox"/>
		-15 mm	Ange antal: _____ 28144	<input type="checkbox"/>
		-45 mm	Ange antal: _____ 28145	<input type="checkbox"/>
	svart Dartex, fast, justerbart i höjd, djup och bredd		27395	<input type="checkbox"/>
	svart PUR, fast, justerbart i höjd och djup		27917	<input type="checkbox"/>
	svart PUR, mellan, sidosvängbart, justerbart i höjd och djup	höger	27915-1	<input type="checkbox"/>
		vänster	27915-2	<input type="checkbox"/>
	svart PUR, stor, sidosvängbart, justerbart i höjd och djup	höger	27916-1	<input type="checkbox"/>
		vänster	27916-2	<input type="checkbox"/>
Ryggkil 	Polyetenscum.	9x2x13 cm (BxHxL)	28030	<input type="checkbox"/>
	Kan klippas till önskad passform.	11x2x18.5 cm (BxHxL)	28139	<input type="checkbox"/>
		17.5x2.5x20 cm (BxHxL)	28140	<input type="checkbox"/>
	Mörkgrå plysch kort	15 cm	63012-60	<input type="checkbox"/>
	lång	30 cm	63013-60	<input type="checkbox"/>
Sidodyna 	Ger ett lätt stöd sidledes. (Kombineras med armstöd samt vid behov sidostopp)	höger	63171-60-1	<input type="checkbox"/>
		vänster	63171-60-2	<input type="checkbox"/>
Sidostopp Rakt eller vinklat. Kombinerar med kil eller sidostödsdyna. 		rak	Ange antal: _____ 28136	<input type="checkbox"/>
		breddning 15 mm	Ange antal: _____ 28137	<input type="checkbox"/>
		breddning 30 mm	Ange antal: _____ 28173	<input type="checkbox"/>
Ekerskydd 	Grått tryck Etac	20"	25502-28	<input type="checkbox"/>
		22"	25503-28	<input type="checkbox"/>
		24"	25504-28	<input type="checkbox"/>
	Gult tryck Etac	20"	25502-29	<input type="checkbox"/>
		22"	25503-29	<input type="checkbox"/>
		24"	25504-29	<input type="checkbox"/>

Etac Cross 5 VB

Standard är markerat med X

Utprovad av: _____

Brukare: _____

Telefon: _____

Datum: _____

Artikel nr	Sitsbredd	Sitslängd	Sitsdjup	
13123201	35 cm	Kort	36-42 cm	<input type="checkbox"/>
13123202	35 cm	Lång	42-48 cm	<input type="checkbox"/>
13123203	37.5 cm	Kort	36-42 cm	<input type="checkbox"/>
13123204	37.5 cm	Lång	42-48 cm	<input type="checkbox"/>
13123205	40 cm	Kort	36-42 cm	<input type="checkbox"/>
13123206	40 cm	Lång	42-48 cm	<input type="checkbox"/>
13123207	42.5 cm	Kort	36-42 cm	<input type="checkbox"/>
13123208	42.5 cm	Lång	42-48 cm	<input type="checkbox"/>
13123209	45 cm	Kort	36-42 cm	<input type="checkbox"/>
13123210	45 cm	Lång	42-48 cm	<input type="checkbox"/>
13123211	47.5 cm	Kort	36-42 cm	<input type="checkbox"/>
13123212	47.5 cm	Lång	42-48 cm	<input type="checkbox"/>
13123213	50 cm	Kort	36-42 cm	<input type="checkbox"/>
13123214	50 cm	Lång	42-48 cm	<input type="checkbox"/>

Chassifärg

93 Mörkblå

Etac Cross 5 VB

Standard är markerat med X
Standard och tillval Cross 5 VB

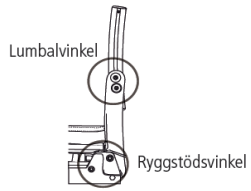
Artikel			Artikel nr		
Ryggstöd Cross 3A		Triangulär	-8° – +18°	<input checked="" type="checkbox"/>	
Rygg		3A standard		<input checked="" type="checkbox"/>	
		3A hög		<input type="checkbox"/>	
Klädsel rygg	Standard reglerbar	35-40 cm	62953-60	<input checked="" type="checkbox"/>	
		42.5-50 cm	62954-60	<input checked="" type="checkbox"/>	
		Hög reglerbar	35-40 cm	63014-60	<input type="checkbox"/>
		42.5-50 cm	63015-60	<input type="checkbox"/>	
Överdrag rygg	Standard	35 cm	62941-60	<input checked="" type="checkbox"/>	
		37.5 cm	62942-60	<input checked="" type="checkbox"/>	
		40 cm	62943-60	<input checked="" type="checkbox"/>	
		42.5 cm	62944-60	<input checked="" type="checkbox"/>	
		45 cm	62945-60	<input checked="" type="checkbox"/>	
		47.5 cm	62946-60	<input checked="" type="checkbox"/>	
	Komfort	50 cm	62947-60	<input checked="" type="checkbox"/>	
		35 cm	62956-60	<input type="checkbox"/>	
		37.5 cm	62957-60	<input type="checkbox"/>	
		40 cm	62958-60	<input type="checkbox"/>	
		42.5 cm	62959-60	<input type="checkbox"/>	
		45 cm	62960-60	<input type="checkbox"/>	
	Hög rygg standard	47.5 cm	62961-60	<input type="checkbox"/>	
		50 cm	62962-60	<input type="checkbox"/>	
		35 cm	63020-60	<input type="checkbox"/>	
		37.5 cm	63021-60	<input type="checkbox"/>	
		40 cm	63022-60	<input type="checkbox"/>	
		42.5 cm	63023-60	<input type="checkbox"/>	
	Hög rygg komfort	45 cm	63024-60	<input type="checkbox"/>	
		47.5 cm	63025-60	<input type="checkbox"/>	
		50 cm	63026-60	<input type="checkbox"/>	
		35 cm	63033-60	<input type="checkbox"/>	
		37.5 cm	63034-60	<input type="checkbox"/>	
		40 cm	63035-60	<input type="checkbox"/>	
		42.5 cm	63036-60	<input type="checkbox"/>	
		45 cm	63037-60	<input type="checkbox"/>	
		47.5 cm	63038-60	<input type="checkbox"/>	
		50 cm	63039-60	<input type="checkbox"/>	

Etac Cross 5 VB

Standard är markerat med X

Airmesh	35 cm	63204-68	<input type="checkbox"/>
	37.5 cm	63205-68	<input type="checkbox"/>
	40 cm	63206-68	<input type="checkbox"/>
	42.5 cm	63207-68	<input type="checkbox"/>
	45 cm	63208-68	<input type="checkbox"/>
	47.5 cm	63209-68	<input type="checkbox"/>
	50 cm	63210-68	<input type="checkbox"/>
Tidy	35 cm	63087-63	<input type="checkbox"/>
	37.5 cm	63088-63	<input type="checkbox"/>
	40 cm	63089-63	<input type="checkbox"/>
	42.5 cm	63090-63	<input type="checkbox"/>
	45 cm	63091-63	<input type="checkbox"/>
	47.5 cm	63092-63	<input type="checkbox"/>
	50 cm	63093-63	<input type="checkbox"/>
Tidy, brodyr utan logga	35 cm	63108-63	<input type="checkbox"/>
	37.5 cm	63109-63	<input type="checkbox"/>
	40 cm	63110-63	<input type="checkbox"/>
	42.5 cm	63111-63	<input type="checkbox"/>
	45 cm	63112-63	<input type="checkbox"/>
	47.5 cm	63113-63	<input type="checkbox"/>
	50 cm	63114-63	<input type="checkbox"/>
Tidy, brodyr med logga	35 cm	63119-63	<input type="checkbox"/>
	37.5 cm	63120-63	<input type="checkbox"/>
	40 cm	63121-63	<input type="checkbox"/>
	42.5 cm	63122-63	<input type="checkbox"/>
	45 cm	63123-63	<input type="checkbox"/>
	47.5 cm	63124-63	<input type="checkbox"/>
	50 cm	63125-63	<input type="checkbox"/>

Rygghöjd	3A std, justerbar 32-45 cm	Ange rygghöjd: _____
	Standard 40 cm	
	3A hög, justerbar 38-51 cm	Ange rygghöjd: _____
	Standard 46 cm	

Ryggvinkel	Justerbar -5- +15 grader	0 gr	<input type="checkbox"/>
		+2 gr	<input checked="" type="checkbox"/>
	Standard +2 gr = 92 gr mellan sits och rygg	+5 gr	<input type="checkbox"/>

Broms		med vinklat rött handtag	höger	27528-1	<input checked="" type="checkbox"/>
			vänster	27528-2	<input checked="" type="checkbox"/>
		med vinklat svart handtag	höger	27532-1	<input type="checkbox"/>
			vänster	27532-2	<input type="checkbox"/>
		med förlängt handtag fällbart	höger	27530-1	<input type="checkbox"/>
	vänster	27530-2	<input type="checkbox"/>		

Etac Cross 5 VB



Enhandsbroms kompl

höger
vänster

Standard är markerat med X

27531-1

27531-2

<input type="checkbox"/>
<input type="checkbox"/>





Etac Cross 5 VB

Standard är markerat med X

Benstöd					
	Vid vinkel svarta			25574-01	<input checked="" type="checkbox"/>
	Snäv vinkel			25570-01	<input type="checkbox"/>
	Snäv vinkel korta			25571-01	<input type="checkbox"/>
	Vid vinkel	låsbara		25575-01	<input type="checkbox"/>
	Snäv vinkel	låsbara		25573-01	<input type="checkbox"/>
	Snäv vinkel korta	låsbara		25572-01	<input type="checkbox"/>
	Vinkelreglerbart mod 1 exkl vadplatta			25660-01	<input type="checkbox"/>
	Vinkelreglerbart mod 3 exkl vadplatta			27149	<input type="checkbox"/>
	Dynkonsol för vadplatta			24544-01	<input type="checkbox"/>
	Dynkonsol FlipUp för vadplatta			27322-01	<input type="checkbox"/>
	Vadplatta mörkgrå	35-37.5 cm		62105-60	<input type="checkbox"/>
		40-42.5 cm		62104-60	<input type="checkbox"/>
		45-47.5 cm		62484-60	<input type="checkbox"/>
		50 cm		62451-60	<input type="checkbox"/>
	Vinkelreglerbart mod 2	höger		25567-1	<input type="checkbox"/>
	inkl uppfällbar vadplatta	vänster		25567-2	<input type="checkbox"/>
	Vinkelreglerbart mod 3				<input type="checkbox"/>
	inkl uppfällbar vadplatta	höger/vänster		26100	<input type="checkbox"/>
	Vinkelreglerbart Prio	42.5-45 cm höger		27857-65-1	<input type="checkbox"/>
	inkl vadplatta grå hygien	vänster		27857-65-2	<input type="checkbox"/>
		47.5-50 cm höger		27858-65-1	<input type="checkbox"/>
		vänster		27858-65-2	<input type="checkbox"/>
	Gipsbenstöd	höger		27417-1	<input type="checkbox"/>
	inkl tre dynor	vänster		27417-2	<input type="checkbox"/>
	Amputationsbenstöd	mörkgrå plysch		25516-60	<input type="checkbox"/>
		svart Dartex		25516-63	<input type="checkbox"/>
	Amputationsvikt kompl			26876	<input type="checkbox"/>
Fotplattor					
	Delade uppfällbara	35 cm		25641-1/2	<input checked="" type="checkbox"/>
	Reglerbar höjd,	37.5 cm		25642-1/2	<input checked="" type="checkbox"/>
	justerbar vinkel och djup	40 cm		25643-1/2	<input checked="" type="checkbox"/>
		42.5 cm		25644-1/2	<input checked="" type="checkbox"/>
		45 cm		25645-1/2	<input checked="" type="checkbox"/>
		47.5 cm		25736-1/2	<input checked="" type="checkbox"/>
		50 cm		25646-1/2	<input checked="" type="checkbox"/>

Etac Cross 5 VB

Standard är markerat med X

	Delade uppfällbara	35 cm	25647-1/2	<input type="checkbox"/>		
	som ovan med längre	37.5 cm	25648-1/2	<input type="checkbox"/>		
	infästningsrör +10 cm	40 cm	25649-1/2	<input type="checkbox"/>		
		42.5 cm	25650-1/2	<input type="checkbox"/>		
		45 cm	25651-1/2	<input type="checkbox"/>		
		47.5 cm	25737-1/2	<input type="checkbox"/>		
		50 cm	25652-1/2	<input type="checkbox"/>		
	Delade uppfällbara	35 cm	25653-1/2	<input type="checkbox"/>		
	som ovan med kortare	37.5 cm	25654-1/2	<input type="checkbox"/>		
	infästningsrör -8 cm	40 cm	25655-1/2	<input type="checkbox"/>		
		42.5 cm	25656-1/2	<input type="checkbox"/>		
		45 cm	25657-1/2	<input type="checkbox"/>		
		47.5 cm	25738-1/2	<input type="checkbox"/>		
		50 cm	25658-1/2	<input type="checkbox"/>		
	Hel fotplatta kompl	35-37.5 cm	25936	<input type="checkbox"/>		
		40-50 cm	25937	<input type="checkbox"/>		
	Hel fotplatta barn kompl	35 cm	26306	<input type="checkbox"/>		
		37.5 cm	26307	<input type="checkbox"/>		
<hr/>						
Hälband		Till delade fotplattor	hö/vä	24458	<input type="checkbox"/>	
<hr/>						
Drivhjul vårdarbroms snabbkopplande med drivring	Högtrycksdäck med drivring:	Aluminium	22"	81342	<input type="checkbox"/>	
		Rostfri	22"	81344	<input type="checkbox"/>	
		Plastad	22"	81343	<input type="checkbox"/>	
		Aluminium	24"	81349	<input checked="" type="checkbox"/>	
		Rostfri	24"	81351	<input type="checkbox"/>	
		Plastad	24"	81350	<input type="checkbox"/>	
		Massivt däck med drivring:				
		Aluminium	20"	81337	<input type="checkbox"/>	
		Aluminium	22"	81339	<input type="checkbox"/>	
		Rostfri	22"	81341	<input type="checkbox"/>	
		Plastad	22"	81343	<input type="checkbox"/>	
		Aluminium	24"	81346	<input type="checkbox"/>	
		Rostfri	24"	81348	<input type="checkbox"/>	
		Plastad	24"	81347	<input type="checkbox"/>	
		Halvmassivt däck m drivring:				
Rostfri	22"	81338	<input type="checkbox"/>			
Rostfri	24"	26282	<input type="checkbox"/>			
<hr/>						
Länkhjul	100 x 30 massivt (max brukarvikt 100 kg)	4"	27870	<input type="checkbox"/>		
	125 x 30 massivt	5"	27865	<input type="checkbox"/>		
	165 x 30 massivt	6.5"	27866	<input checked="" type="checkbox"/>		

Etac Cross 5 VB

Standard är markerat med X

Framgaffel stålaxel	Kort	24677	<input type="checkbox"/>
	Medium	24678	<input checked="" type="checkbox"/>
	Kort för 4" länkhjul	26238	<input type="checkbox"/>

Framgaffelfäste För extra låg sitthöjd Ger utökat sparkutrymme	Standard	28147	<input checked="" type="checkbox"/>
	Lågt	28175	<input type="checkbox"/>
	Breddat	25763	<input type="checkbox"/>

Camberbricka	2°	bricka yttre 2 st	82567	<input checked="" type="checkbox"/>
		bricka inre 2 st	82568	<input checked="" type="checkbox"/>
	0°	bricka yttre 2 st	82569	<input type="checkbox"/>
		bricka inre 2 st	82570	<input type="checkbox"/>

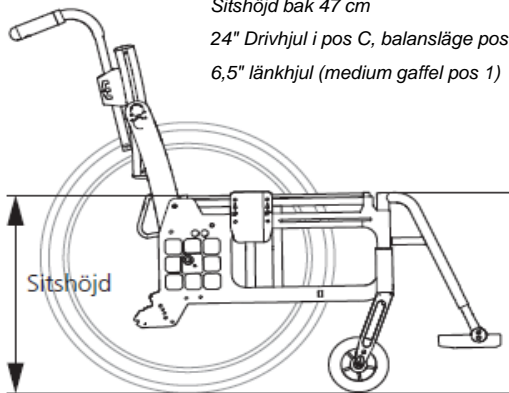
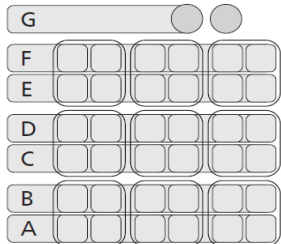
Sitthöjd bak	Drivhjulposition	20" pos G	34 cm	<input type="checkbox"/>
		20" pos F	36 cm	<input type="checkbox"/>
 <p>Sitshöjd bak 47 cm 24" Drivhjul i pos C, balansläge pos 4 6,5" länkhjul (medium gaffel pos 1)</p>	20" pos E	38 cm	<input type="checkbox"/>	
	20" pos D	40 cm	<input type="checkbox"/>	
	20" pos C	42 cm	<input type="checkbox"/>	
	20" pos B	44 cm	<input type="checkbox"/>	
	20" pos A	46 cm	<input type="checkbox"/>	
	22" pos G	36.5 cm	<input type="checkbox"/>	
	22" pos F	38.5 cm	<input type="checkbox"/>	
	22" pos E	40.5 cm	<input type="checkbox"/>	
	22" pos D	42.5 cm	<input type="checkbox"/>	
	22" pos C	44.5 cm	<input type="checkbox"/>	
22" pos B	46.5 cm	<input type="checkbox"/>		
22" pos A	48.5 cm	<input type="checkbox"/>		
	24" pos G	39 cm	<input type="checkbox"/>	
	24" pos F	41 cm	<input type="checkbox"/>	
	24" pos E	43 cm	<input type="checkbox"/>	
	24" pos D	45 cm	<input type="checkbox"/>	
	24" pos C	47 cm	<input checked="" type="checkbox"/>	
	24" pos B	49 cm	<input type="checkbox"/>	
	24" pos A	51 cm	<input type="checkbox"/>	

Etac Cross 5 VB

Standard är markerat med X

Sitthöjd fram

Framgaffelposition

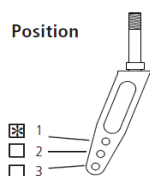

Länkhjul / Framgaffel

4" / extra kort

5" / kort

6,5" / kort

5" / medium

6,5" / medium

6,5" / lång*

8" * / medium

8" * / lång*

* 8" länkhjul och lång gaffel

beställs separat. Se reservdelar

höjd 34-39.5 cm

höjd 36-44.5 cm

höjd 41-46.5 cm

höjd 43-49 cm

höjd 46-51 cm (std 47 cm)

höjd 50.5-55.5 cm

höjd 48-52 cm

höjd 52.5-56.5 cm

Ange höjd

_____ cm	
_____ cm	
_____ cm	
_____ cm	
_____ cm	X

Balansläge

Standard pos 4

Alternativa sitthöjder/sitsvinklar
Se tabell i manual Cross

Välj balansläge 1-6 _____

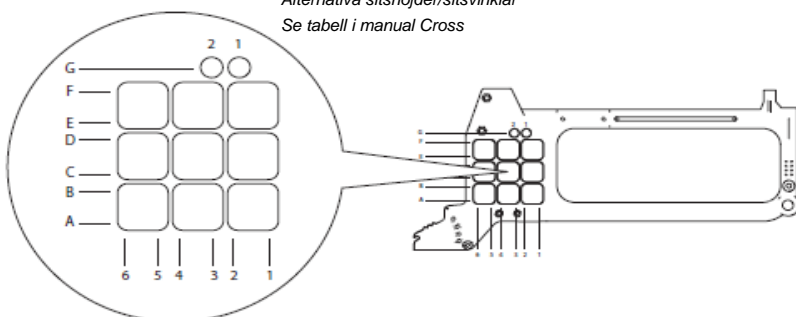

Klädsel sits

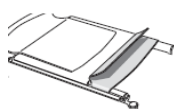

Svart tyg, reglerbar i djup

Basic kort (kort sitsdjup)

35 cm

62718-60

X

37.5 cm

62719-60

X

40 cm

62720-60

X

42.5 cm

62721-60

X

45 cm

62722-60

X

47.5 cm

62978-60

X

50 cm

62979-60

X

Basic lång (långt sitsdjup)

35 cm

62728-60

X

37.5 cm

62729-60

X

40 cm

62730-60

X

42.5 cm

62731-60

X

45 cm

62732-60

X

47.5 cm

62984-60

X

50 cm

62985-60

X

Etac Cross 5 VB

Standard är markerat med X

Hård sits				
	kort sitsdjup	35-37.5 cm	26720	<input type="checkbox"/>
		40-42.5 cm	26721	<input type="checkbox"/>
		45-47.5 cm	26722	<input type="checkbox"/>
		50 cm	26723	<input type="checkbox"/>
	långt sitsdjup	35-37.5 cm	26725	<input type="checkbox"/>
		40-42.5 cm	26726	<input type="checkbox"/>
		45-47.5 cm	26727	<input type="checkbox"/>
		50 cm	26728	<input type="checkbox"/>

Sitsförlängare klädsel Crossrygg mod 3		35-42,5 cm	62976	<input checked="" type="checkbox"/>
		45-60 cm	62977	<input checked="" type="checkbox"/>

Förlänger sitsen 7 cm i bakkant tillsammans med triangulär rygg

Handtag vårdarbroms	höger/vänster 	75 mm	27339-01	<input checked="" type="checkbox"/>
		100 mm	27625-01	<input type="checkbox"/>

Armstöd		kort med ingjuten massiv platta längd 25 cm höjddjusterbara	höger	25172-1	<input checked="" type="checkbox"/>
			vänster	25172-2	<input checked="" type="checkbox"/>
		lång med avtagbar armstödsdyna längd 25 cm höjddjusterbara	höger	27230-1	<input type="checkbox"/>
			vänster	27230-2	<input type="checkbox"/>
		lång med ingjuten massiv platta längd 38 cm höjddjusterbara	höger	25173-1	<input type="checkbox"/>
			vänster	25173-2	<input type="checkbox"/>
		lång med avtagbar armstödsdyna längd 35 cm höjddjusterbara	höger	27231-1	<input type="checkbox"/>
			vänster	27231-2	<input type="checkbox"/>
		Uppfällbara fasta <i>Finns restriktioner, se rullstolens manual</i>	höger	25551-1	<input type="checkbox"/>
			vänster	25551-2	<input type="checkbox"/>
	Uppfällbara höjddjusterbara <i>Finns restriktioner, se rullstolens manual</i>	höger	25546-1	<input type="checkbox"/>	
		vänster	25546-2	<input type="checkbox"/>	
	Stänkskärm svart	höger	27397-1	<input type="checkbox"/>	
		vänster	27397-2	<input type="checkbox"/>	







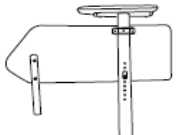

Tippskydd 	Tippskydd teleskoperande	kompl	27526	<input checked="" type="checkbox"/>
--	---------------------------------	-------	-------	-------------------------------------

Transportfäste 	Transportfäste kompl	höger vänster	82573 82574	<input checked="" type="checkbox"/> <input checked="" type="checkbox"/>
---	-----------------------------	------------------	----------------	--

Etac Cross 5 VB

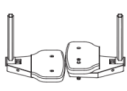

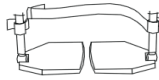

Standard är markerat med X

Tillbehör Cross 5 VB

Artikel		Artikel nr				
Lårstöd 	Monteras på korta alt. långa armstöd, komplett Passar ej med 22" drivhjul i pos. C1. Passar ej med 24" drivhjul i pos. C1 eller B1.					
	kort höger	27391-1	<input type="checkbox"/>			
	kort vänster	27391-2	<input type="checkbox"/>			
	lång höger	27392-1	<input type="checkbox"/>			
	lång vänster	27392-2	<input type="checkbox"/>			
Mjukdyna 						
	höger vänster	82488-1 82488-2	<input type="checkbox"/> <input type="checkbox"/>			
Tillbehör armstöd 	Armstödsdyna Hemi (passar till 27231-1/2)	höger vänster	27313-60-1 27313-60-2	<input type="checkbox"/> <input type="checkbox"/>		
	Armstödsdyna Hemi (passar till 25173-1/2)	höger vänster	25770-60-1 25770-60-2	<input type="checkbox"/> <input type="checkbox"/>		
		Armstödsdyna polstrad mörkgrå plysch, 25 el 38 cm långt (passar till 25172-1/2 och 25173-1/2)	kort antal: _____ lång antal: _____	62282-60 62283-60	<input type="checkbox"/> <input type="checkbox"/>	
		Armstödsdyna Gel mörkgrå plysch, 25 el 38 cm långt (passar till 25172-1/2 och 25173-1/2)	kort antal: _____ lång antal: _____	26240-60 26241-60	<input type="checkbox"/> <input type="checkbox"/>	
		Armstödsdyna bred och mjuk (passar till 25172-1/2 och 25173-1/2)	8x40 cm	26873	<input type="checkbox"/>	
	Fotplatta 	Förlängningsdel (Monteras på befintlig fotplatta)	40-42.5 cm antal: _____	50798	<input type="checkbox"/>	
			45-47.5 cm antal: _____	50799	<input type="checkbox"/>	
			50 cm antal: _____	50800	<input type="checkbox"/>	
	Polstring fotplattor 	Delade fotplattor	35 - 40 höger	63188-60-1	<input type="checkbox"/>	
			35 - 40 vänster	63188-60-2	<input type="checkbox"/>	
42.5 - 50 höger			63189-60-1	<input type="checkbox"/>		
42.5 - 50 vänster			63189-60-2	<input type="checkbox"/>		
52.5 - 60 höger			63192-60-1	<input type="checkbox"/>		
52.5 - 60 vänster			63192-60-2	<input type="checkbox"/>		
			Hel fotplatta	40 - 47.5	63190-60	<input type="checkbox"/>
				50 - 60	63191-60	<input type="checkbox"/>
Vadband 	Avtagbart och delbart nylon	35-37.5 cm	25356	<input type="checkbox"/>		
		40-42.5 cm	25357	<input type="checkbox"/>		
		45-47.5 cm	25358	<input type="checkbox"/>		
		50 cm	25359	<input type="checkbox"/>		
Polstring för vadband 		20 cm	26845	<input type="checkbox"/>		
		30 cm	26846	<input type="checkbox"/>		
		40 cm	26847	<input type="checkbox"/>		
Vadmatta 	Plysch. Monteras/justeras med kardborre	75 cm	63186-60	<input type="checkbox"/>		
		90 cm	63187-60	<input type="checkbox"/>		



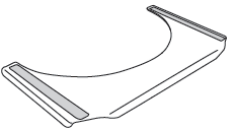
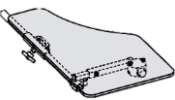







Etac Cross 5 VB

Standard är markerat med X

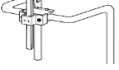
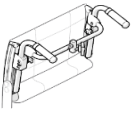
Överdrag vadplatta	 till vrb benstöd 26100	Dartex	62762-63	<input type="checkbox"/>	
Bord		Transparent, monteras på långa armstöd	35 cm	24417	<input type="checkbox"/>
		Storlek=stolens bredd	37.5 cm	25187	<input type="checkbox"/>
			40 cm	24418	<input type="checkbox"/>
			42.5 cm	25188	<input type="checkbox"/>
			45 cm	24419	<input type="checkbox"/>
			47.5 cm	25731	<input type="checkbox"/>
			50 cm	24601	<input type="checkbox"/>
Hemibord		Transparent	35 cm kort överdrag	26556	<input type="checkbox"/>
		Storlek=stolens bredd	35 cm långt överdrag	26563	<input type="checkbox"/>
			37,5 cm kort överdrag	26557	<input type="checkbox"/>
			37,5 cm långt överdrag	26564	<input type="checkbox"/>
			40 cm kort överdrag	26558	<input type="checkbox"/>
			40 cm långt överdrag	26565	<input type="checkbox"/>
			42,5 cm kort överdrag	26559	<input type="checkbox"/>
			42,5 cm långt överdrag	26566	<input type="checkbox"/>
			45 cm kort överdrag	26560	<input type="checkbox"/>
			45 cm långt överdrag	26567	<input type="checkbox"/>
			47,5 cm kort överdrag	26561	<input type="checkbox"/>
			47,5 cm långt överdrag	26568	<input type="checkbox"/>
			50 cm kort överdrag	26562	<input type="checkbox"/>
	50 cm långt överdrag	26569	<input type="checkbox"/>		
Hemibord halvt Kommunikation		Halkskydd hemibord		81633	<input type="checkbox"/>
			höger	27352-1	<input type="checkbox"/>
		vänster	27352-2	<input type="checkbox"/>	
Fäste bord kompl	Rund infästning. Passar rör upp till 18 mm i diameter.	höger	27956-1	<input type="checkbox"/>	
		vänster	27956-2	<input type="checkbox"/>	
Sittdyna		Universal mörkgrå	35 cm	62230-60	<input type="checkbox"/>
		Mörkgrå plysch, 56 cm lång, anatomiskt formad, kapas till inställt sitsdjup.	37.5 cm	62231-60	<input type="checkbox"/>
			40 cm	62232-60	<input type="checkbox"/>
			42.5 cm	62233-60	<input type="checkbox"/>
			45 cm	62234-60	<input type="checkbox"/>
			47.5 cm	62374-60	<input type="checkbox"/>
			50 cm	62266-60	<input type="checkbox"/>
	Tidy Avtorkningsbar	35 cm	63098-63	<input type="checkbox"/>	
		37.5 cm	63099-63	<input type="checkbox"/>	
		40 cm	63100-63	<input type="checkbox"/>	
		42.5 cm	63101-63	<input type="checkbox"/>	
		45 cm	63102-63	<input type="checkbox"/>	
		47.5 cm	63103-63	<input type="checkbox"/>	
		50 cm	63104-63	<input type="checkbox"/>	

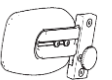
Etac Cross 5 VB

Standard är markerat med X

Komfortkil sittdyna	Universal 	35-37.5 cm	80714	<input type="checkbox"/>	
		40-45 cm	80715	<input type="checkbox"/>	
		47.5-50 cm	80779	<input type="checkbox"/>	
Höftbälte	med snäpplås, avkortbart.	100 cm	25668	<input type="checkbox"/>	
Bälte 	2 alternativa fästpunkter på ramen	128 cm	26163	<input type="checkbox"/>	
	med snäpplås, helt	170 cm	62190	<input type="checkbox"/>	
Huvudstöd inkl stag. Mont på körbygel/tvärstag	 Mod 4 hygien grå	260x140 mm	28223-65	<input type="checkbox"/>	
	Mod 4 mörkgrå plysch	260x140 mm	28223-60	<input type="checkbox"/>	
	Huvudstöd med sidostöd <i>Reglerbara i höjd, djup, vinkel och sidledes</i>	hygien grå	28325-65	<input type="checkbox"/>	
	Huvudstödsfäste för körbygel kompl		25795	<input type="checkbox"/>	
	Huvudstödsfäste för tvärstag kompl Crossrygg 3A, mod 4	Stolsbredd		<input type="checkbox"/>	
		35 cm	28125	<input type="checkbox"/>	
		37.5 cm	28126	<input type="checkbox"/>	
		40 cm	28127	<input type="checkbox"/>	
		42.5 cm	28128	<input type="checkbox"/>	
		45 cm	28129	<input type="checkbox"/>	
	47.5 cm	28130	<input type="checkbox"/>		
	50 cm	28131	<input type="checkbox"/>		
Bålstöd		justerbart, sidosvängbart och avtagbart	0 mm hö	28181-1	<input type="checkbox"/>
			0 mm vä	28181-2	<input type="checkbox"/>
			-15 mm hö	28180-1	<input type="checkbox"/>
			-15 mm vä	28180-2	<input type="checkbox"/>
			-45 mm hö	28141-1	<input type="checkbox"/>
			-45 mm vä	28141-2	<input type="checkbox"/>
	justerbart och avtagbart	0 mm	Ange antal: _____	28142	<input type="checkbox"/>
		+15 mm	Ange antal: _____	28143	<input type="checkbox"/>
		-15 mm	Ange antal: _____	28144	<input type="checkbox"/>
		-45 mm	Ange antal: _____	28145	<input type="checkbox"/>
	svart Dartex, fast, justerbart i höjd, djup och bredd			27395	<input type="checkbox"/>
					<input type="checkbox"/>
	svart PUR, fast, justerbart i höjd och djup			27917	<input type="checkbox"/>
					<input type="checkbox"/>
	svart PUR, mellan, sidosvängbart, justerbart i höjd och djup	höger		27915-1	<input type="checkbox"/>
		vänster		27915-2	<input type="checkbox"/>
	svart PUR, stor, sidosvängbart, justerbart i höjd och djup	höger		27916-1	<input type="checkbox"/>
		vänster		27916-2	<input type="checkbox"/>

Etac Cross 5 VB

Standard är markerat med X

Tvärstag

med snäplåsning

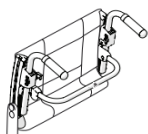

Stolsbredd

35 cm	28114	<input type="checkbox"/>
37.5 cm	28115	<input type="checkbox"/>
40 cm	28116	<input type="checkbox"/>
42.5 cm	28117	<input type="checkbox"/>
45 cm	28118	<input type="checkbox"/>
47.5 cm	28119	<input type="checkbox"/>
50 cm	28120	<input type="checkbox"/>

Ryggkil



Polyetenskum.
Kan klippas till önskad passform.

9x2x13 cm (BxHxL)	28030	<input type="checkbox"/>
11x2x18.5 cm (BxHxL)	28139	<input type="checkbox"/>
17.5x2.5x20 cm (BxHxL)	28140	<input type="checkbox"/>



Mörkgrå plysch kort
lång

15 cm	63012-60	<input type="checkbox"/>
30 cm	63013-60	<input type="checkbox"/>

Sidodyna



Ger ett lätt stöd sidledes.
(Kombineras med armstöd
samt vid behov sidostopp)

höger	63171-60-1	<input type="checkbox"/>
vänster	63171-60-2	<input type="checkbox"/>

Sidostopp

Rakt eller vinklat. Kombinera
med kil eller sidostödsdyna.

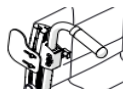

rak	Ange antal: _____	28136	<input type="checkbox"/>
breddning 15 mm	Ange antal: _____	28137	<input type="checkbox"/>
breddning 30 mm	Ange antal: _____	28173	<input type="checkbox"/>

Ekerskydd



Grått tryck Etac

20"	25502-28	<input type="checkbox"/>
22"	25503-28	<input type="checkbox"/>
24"	25504-28	<input type="checkbox"/>

Gult tryck Etac

20"	25502-29	<input type="checkbox"/>
22"	25503-29	<input type="checkbox"/>
24"	25504-29	<input type="checkbox"/>

Käpphållare



Universal

höger	27327	<input type="checkbox"/>
vänster	27327	<input type="checkbox"/>

Droppställning



Komplett

28323

Tetra quick release adapter



Ange antal: _____ 24051-01